

# PA Primo Alu

Primo System PA31 - indadgående vinduesdøre med 25 mm bundstykke 120

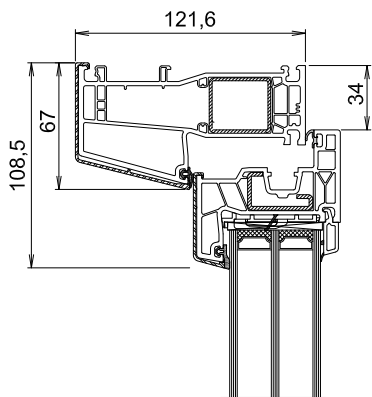

L20 =  
A576/76107(V381) - A036/76200(V315) - 76509

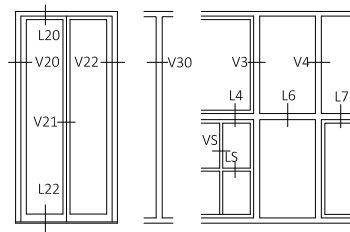
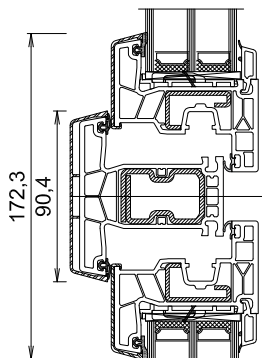

L4 =  
A036/76200(V315) - A046/76302(V319) -  
A036/76200(V315) - 76509

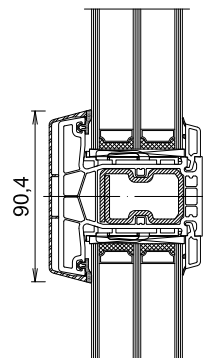

L6 =  
A046/76302(V319) - 76509

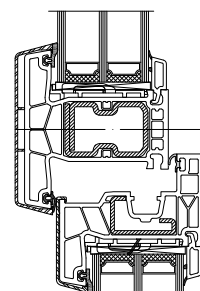

L7 =  
A046/76302(V319) -  
A036/76200(V315) - 76509

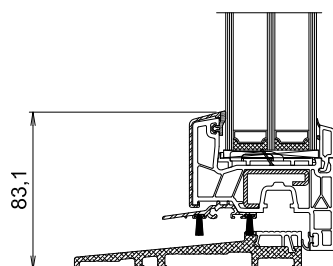

L22 =  
Z188/A061 - A036/76200(V315) - 76509

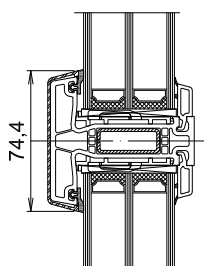

LS,VS =  
A045/76300(V312) - 76509

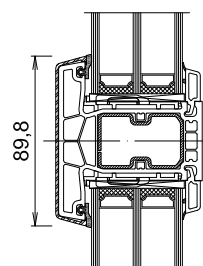

LS,VS =  
A069/76302(V343) - 76509

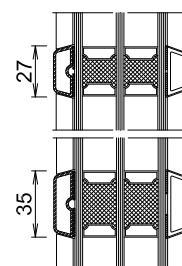

LS =  
27 mm (A244T, 92001), 35 mm (A246T, 92003)

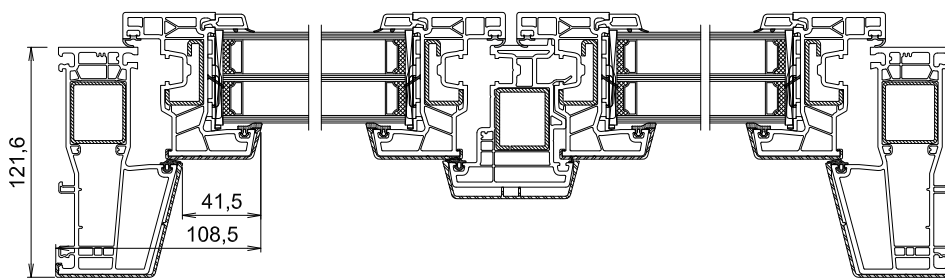

V20 =  
A576/76107(V381) -  
A036/76200(V315) - 76509

V21 =  
A036/76200(V315) - 76509 - A050/76402 (V310)  
A036/76200(V315) - 76509

V22 =  
A576/76107(V381) -  
A036/76200(V315) - 76509

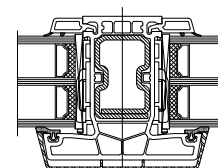

V30 =  
A046/76302(V319) - 76509

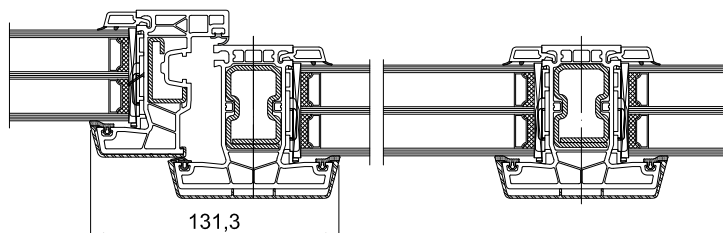

V3 =  
A046/76302(V319) -  
A036/76200(V315) - 76509

V4 =  
A046/76302(V319) - 76509

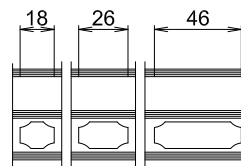

LS,VS =  
ilagt sprosse 18 mm, 26 mm, 46 mm

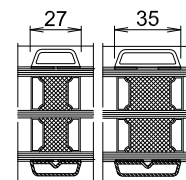

VS =  
27 mm (A243T, 92000),  
35 mm (A245T, 92002)