

PA Primo Alu

Primo System PA50 - Indadgående facadedør standard ramme 120

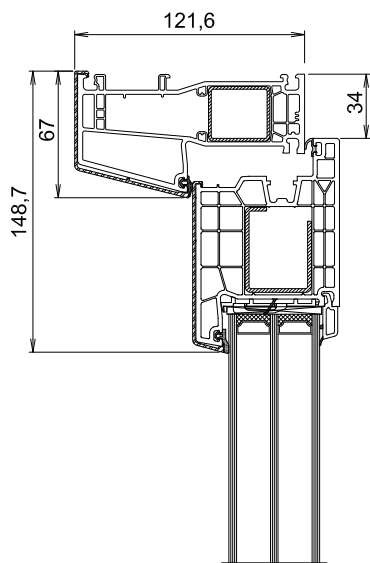

L20 =
A576/76107(V381) -
A038/76204(V326) - 76509

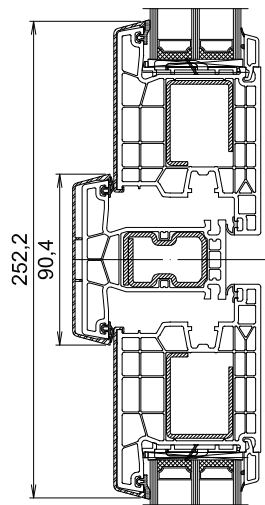

L4 =
A038/76204(V326) - A046/76302(V319) -
A038/76204(V326) - 76509

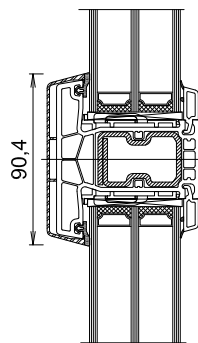

L6 =
A046/76302(V319) - 76509

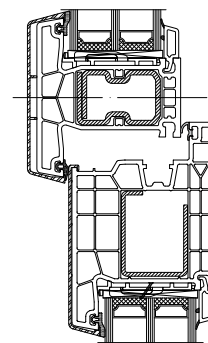
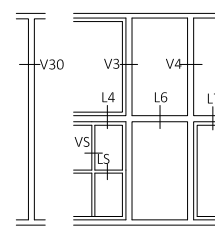

L7 =
A046/76302(V319) -
A038/76204(V326) - 76509

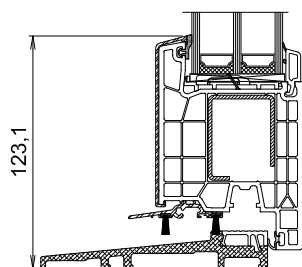

L22 =
Z188/A061 - A038/76204(V326) - 76509

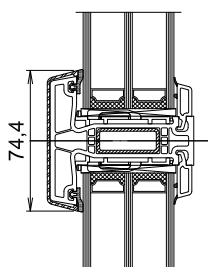

LS, VS =
A045/76300(V312) - 76509

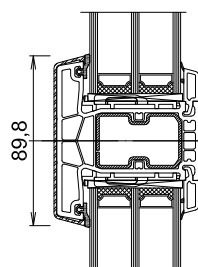

LS, VS =
A069/76302(V343) - 76509

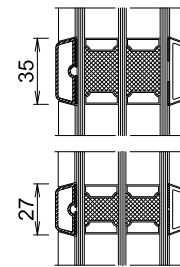

LS =
27 mm (A244T, 92001), 35 mm (A246T, 92003)

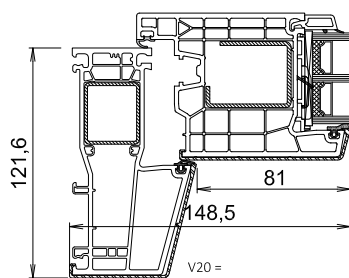

V20 =
A576/76107(V381) -
A038/76204(V326) - 76509

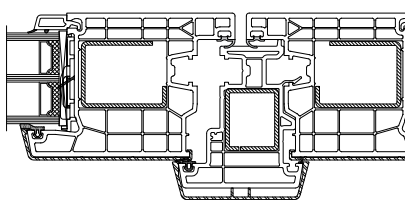

V21 =
A038/76204(V326) - 76509 - A050/76402 (V310)
A038/76204(V326) - 76509

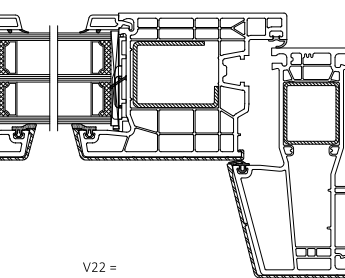

V22 =
A576/76107(V381) -
A038/76204(V326) - 76509

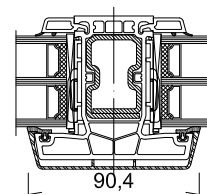

V30 =
A046/76302(V319) - 76509

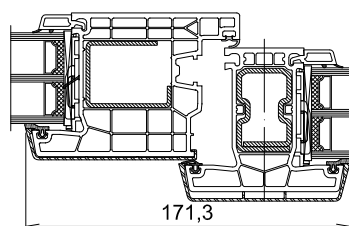

V3 =
A038/76204(V326) -
A046/76302(V319) - 76509

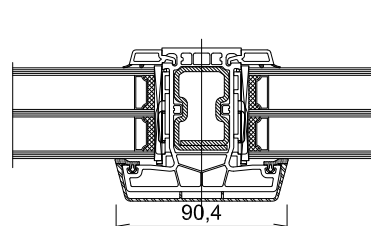

V4 =
A046/76302(V319) - 76509

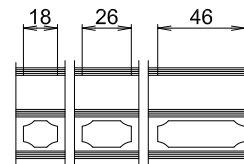

LS, VS =
ilagt sprosse 18 mm, 26 mm, 46 mm

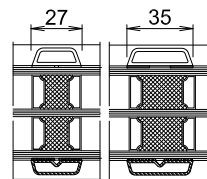

VS =
27 mm (A243T, 92000),
35 mm (A245T, 92002)