

# PP Primo Plast

## Primo System PP10 - Indadgående vinduer 120

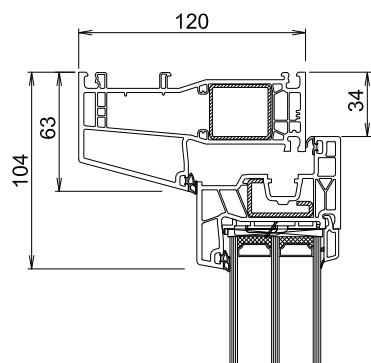

L1 =  
76107(V381) - 76200(V315) - 76509

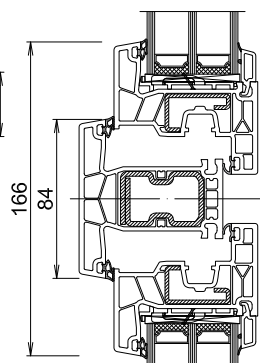

L4 =  
76200(V315) - 76302(V319) - 76200(V315) - 76509

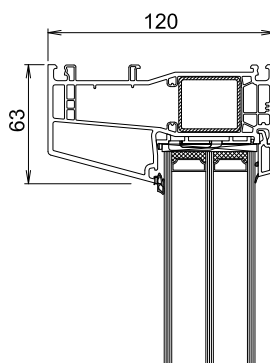

L5 =  
76107(V381) - 76509

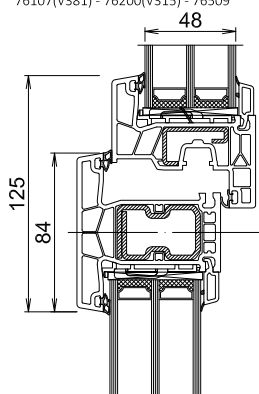
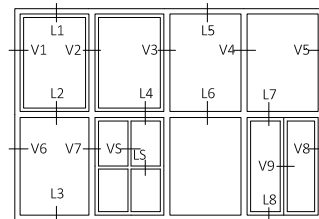

L2 =  
76200(V315) - 76509 - 76302(V319) - 76509

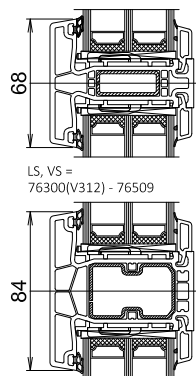

LS, VS =  
76300(V312) - 76509

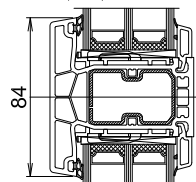

LS, VS =  
76302(V343) - 76509

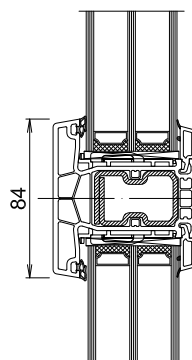

L6 =  
76302(V319) - 76509

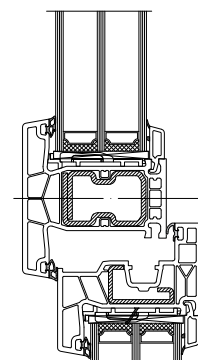

L7 =  
76302(V319) - 76509 - 76200(V315) - 76509

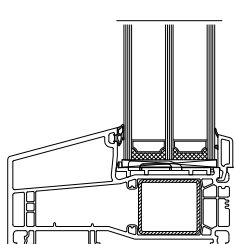

L3 (02) =  
76107(V381) - 76509

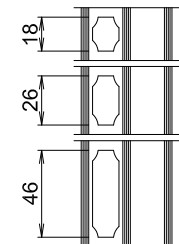

LS =  
ilagt sprosse 18 mm, 26 mm, 46 mm

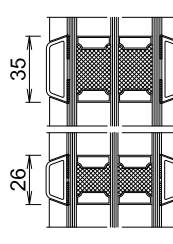

LS =  
27 mm (92001), 35 mm (92003)

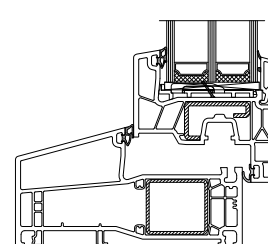

L8 =  
76107(V381) - 76200(V315) - 76509

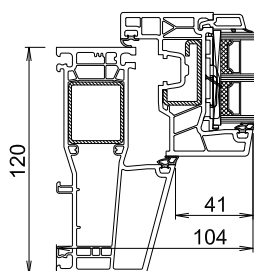

V1 =  
76107(V381) - 76200(V315) - 76509

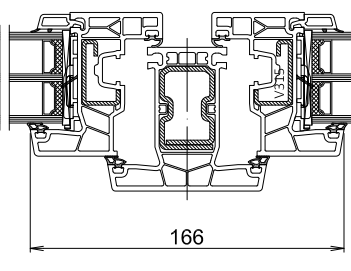

V2 =  
76200(V315) - 76302(V319) - 76200(V315) - 76509

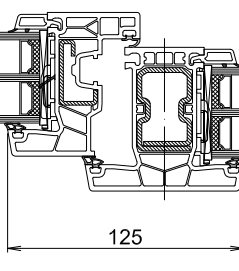

V3 =  
76200(V315) -- 76302(V319) - 76509

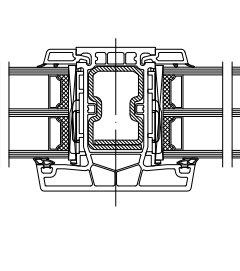

V4 =  
76302(V315) - 76509

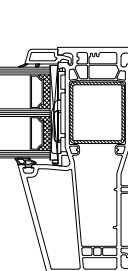

V5 =  
76107(V381) - 76509

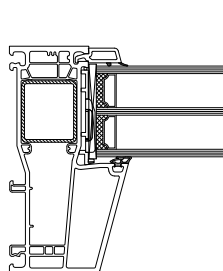

V6 =  
76107(V381) - 76509

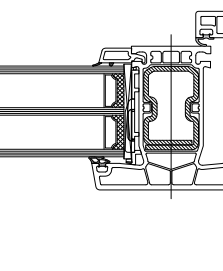

V7 =  
76200(V315) - 76302(V319) - 76509

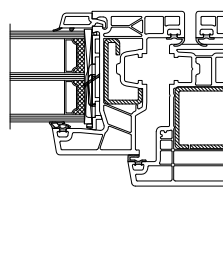

V9 =  
76200(V315) - 76509 76402 (V310) 76200(V315) - 76509

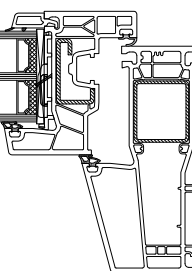

V8 =  
76107(V381) - 76200(V315) - 76509