

L20 =
76107(V381) - 76204(V326) - 76509

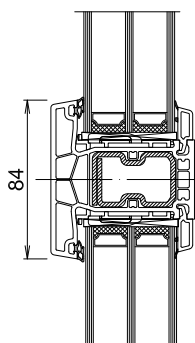

L6 =
76302(V319) - 76509

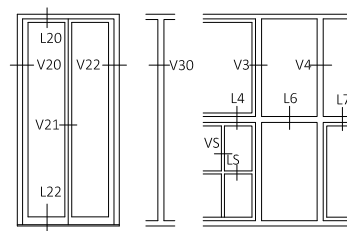
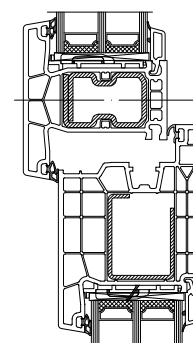

L7 =
76302(V319) - 76204(V326) - 76509

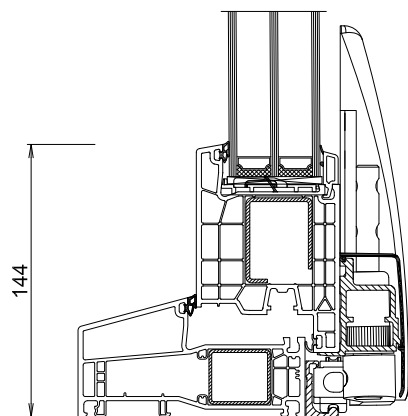

L22 =
Z188/A061 - 76204(V326) - 76509

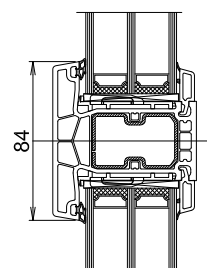

LS,VS =
76302(V343) - 76509

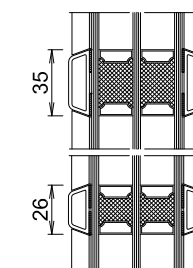

LS =
26 mm (92001), 35 mm (92003)

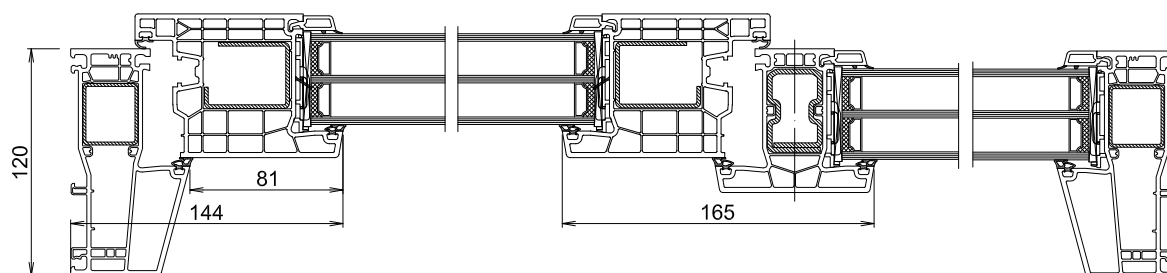

V20 =
76107(V381) - 76204(V326) - 76509

V3 =
76204(V326) - 76302(V319) - 76509

V5 =
76107(V381) - 76509

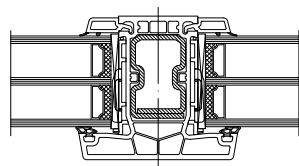

V30 =
76302(V315) - 76509

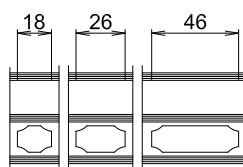

LS,VS =
flågt sprosse 18 mm, 26 mm, 46 mm

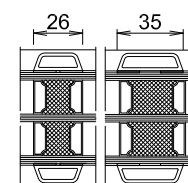

VS =
27 mm (92000), 35 mm (92002)